



»» Features

- New generation sugar cube relay for application.
- NO terminal with double pin type are available.
- High insulation with barrier type are available.
- CTI 250 material or product comply with IEC60335-1 are available.
- Complies with RoHS-Directive 2011/65/EU.

»» Type List

◆ High Power Type

Terminal style	Contact form	Insulation system	Designation (provided with)
			Flux tight
PCB terminal	1A(SPNO)	F	215H-1AH-F-C
	1C(SPDT)	F	215H-1CH-F-C

◆ High Power & High Temperature Type

Terminal style	Contact form	Insulation system	Designation (provided with)
			Flux tight
PCB terminal	1A(SPNO)	F	215HT-1AC-F-C

»» Ordering Information

215H - - F - C

1 2 3 4 5 6 7 8

- | | |
|---|--|
| <p>1. 215H -- High power type</p> <p>215BH -- High power type with insulation barrier</p> <p>215HT -- High power & High temperature type</p> <p>215BHT -- High power & High temperature type with insulation barrier</p> <p>2. Blank -- Standard type</p> <p style="margin-left: 20px;">A -- Double pin type</p> <p>3. 1A -- Single pole normally open</p> <p style="margin-left: 20px;">1C -- Single pole double throw</p> | <p>4. C -- Contact material AgNi</p> <p style="margin-left: 20px;">H -- Contact material AgSnO</p> <p>5. F -- Class F</p> <p>6. C -- Flux tight</p> <p style="margin-left: 20px;">V -- Sealed type</p> <p>7. Blank -- Standard type</p> <p style="margin-left: 20px;">E1 -- Comply with IEC 60335-1</p> <p>8. <input type="checkbox"/> -- Coil voltage (please refer to the coil rating data for the availability)</p> |
|---|--|

»» Contact Rating

Type	215H	215HT
Rated load (Resistive)	NO: 10A 250VAC, 12A 120VAC NC: 8A 250VAC ^(※) , 10A 120VAC ^(※)	NO: 17A 250VAC ^(※) , 10A 250VAC, at 105°C, 200K ops.
Max. switching current	17A	20A
Max. switching voltage	277VAC	277VAC
Max. switching capacity	2500VA	4250VA

215H

»» Coil Rating (DC)

Rated voltage (V)	Rated current $\pm 10\%$ at 23°C (mA)	Coil resistance $\pm 10\%$ at 23°C (Ω)	Max. continuous voltage at 85°C	Pick up voltage(Max.) at 23°C	Drop out voltage(Min.) at 23°C	Power consumption at rated voltage
3	133	22.5	130 % of rated voltage	75 % of rated voltage	10 % of rated voltage	approx. 0.4W
5	80	62.5				
6	66.7	90				
9	44.4	202.5				
12	33.3	360				
15	26.7	562				
18	22.2	811				
24	16.7	1,440				
36	11.1	3,240				
48	8.3	5,760				

»» Specification

Contact material	AgSnO / AgNi alloy	
Contact resistance ⁽¹⁾	100m Ω Max. (at 1A/6VDC by 4-wire resistance measurement)	
Operate time ⁽¹⁾	15ms Max.	
Release time ⁽¹⁾	5ms Max.	
Vibration resistance	Operating extremes	10~50Hz , amplitude 1.0 mm
	Damage limits	10~50Hz , amplitude 1.0 mm
Shock resistance	Operating extremes	10G
	Damage limits	100G
Life expectancy	Mechanical	10,000,000 ops. (frequency 18,000 ops./hr)
	Resistive load	100,000 ops. (frequency 360 ops./hr)
		(※)50,000 ops. (frequency 360 ops./hr)
Operating ambient temperature	-40~+85°C (no freezing) (for 215H) -40~+105°C (no freezing) (for 215HT)	
Weight	Approx. 10 g	

Note : (1) Initial value. Operate and release time excluding contact bounce.

(2) Unless otherwise specified, all tests are under room temperature and humidity.

(3) Consider the heat of PCB is necessary, please check the actual condition of PCB.

(4) Applying no diode to this relay. The life expectancy will be lower when a diode is used. To use a varistor (ZNR) could absorb the coil surge of relay that is recommended.

(5) Do not use the relay exceeding the coil rating, contact rating and life expectancy, or this may cause the risk of overheating.

(6) To assure optimum performance, avoid the relay from dropping, hitting, or other unnecessary shocks.

(7) Do not switch the contacts without any load as the contact resistance may become increased rapidly.

(8) Flux tight version is recommended. If there is cleaning process and sealed type is selected, the vent-hole should be removed after the process.

(9) Usage, transport and storage conditions

- 1. Temperature: 215H : -40~+85°C 215HT : -40~+105°C
- 2. Humidity: 5 to 85% R.H.
- 3. Pressure: 86 to 106 kPa
- Furthermore, the humidity range varies with the temperature. So, use relays within the range indicated in the graph below.

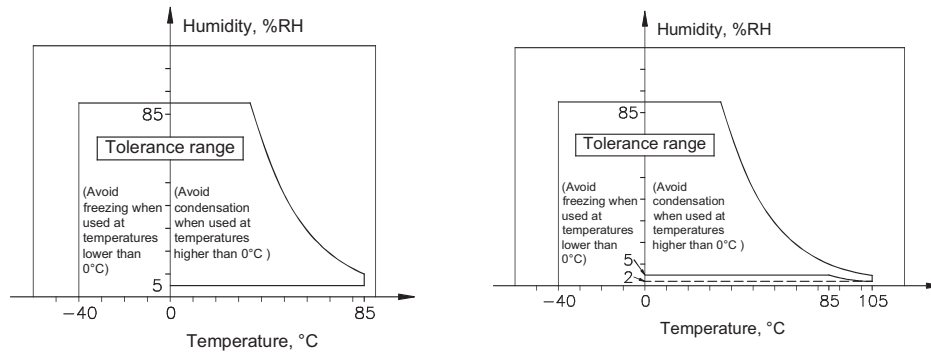

(10) Please contact Song Chuan for the detailed information.

»» Insulation Data

Insulation resistance ⁽¹⁾	100 MΩ Min. (DC 500V)
Dielectric strength ⁽¹⁾	Between open contact : AC 750V , 50/60Hz 1 min. (for 215H / 215HT) : AC 1000V , 50/60Hz 1 min. (for 215BH)
	Between contact and coil : AC 1500V , 50/60Hz 1 min. (for 215H / 215HT) : AC 2000V , 50/60Hz 1 min. (for 215BH)
Insulation of IEC 61810-1	
Clearance / creepage distances	Between coil to contact : Basic, ≥ 1.5mm / ≥ 2.5mm
	Between open contact : Functional
Rated insulation voltage	250V
Rated impulse withstand voltage	2500V
Pollution degree	2
Rated voltage	250V
Overvoltage category	II

Note : (1) Initial value.

»» Safety Approval

Certified	UL / CUL	VDE
File No.	E88991	40045980

215H

»» Safety Approval Rating

◆ 215H Type

UL / CUL		VDE	
NO	NC	NO	NC
20A 125VAC 17A 277VAC 10A 30VDC 1/2HP 125VAC(AgSnO) 1HP 250VAC(AgSnO) TV5(AgSnO)	20A 125VAC(AgSnO) 10A 277VAC 7A 30VDC 1/2HP 125VAC(AgSnO) 1HP 250VAC(AgSnO)	17A 125VAC T85 10A 250VAC T105	17A 125VAC T85 10A 250VAC T105

◆ 215HT Type

UL / CUL	VDE
NO	NO
20A 277VAC 17A 277VAC	17A 250VAC T105

»» Outline Dimensions

◆ 215

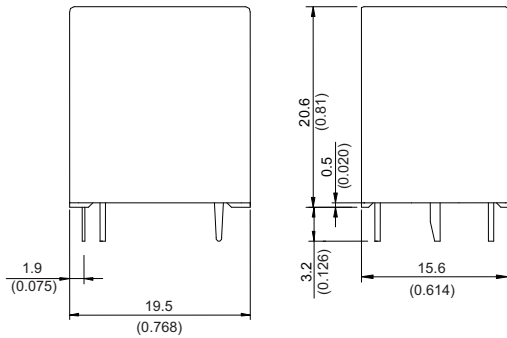

◆ 215A

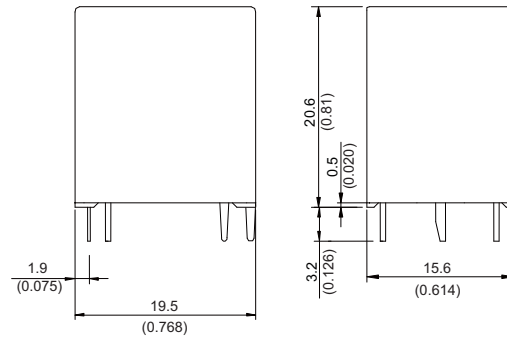

TOLERANCE:
 LESS THAN: 1(0.039) ±0.1(0.004)
 5(0.197) ±0.3(0.012)
 20(0.787) ±0.5(0.020)
 MORE THAN: 20(0.787) ±1(0.039)

»» Wiring Diagram

BOTTOM VIEW

◆ 215

1C

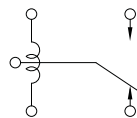

1A

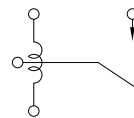

◆ 215A

1C

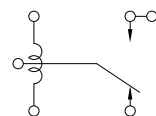

1A

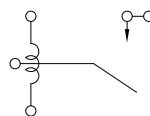

PC Board Layout

BOTTOM VIEW

◆215 1C

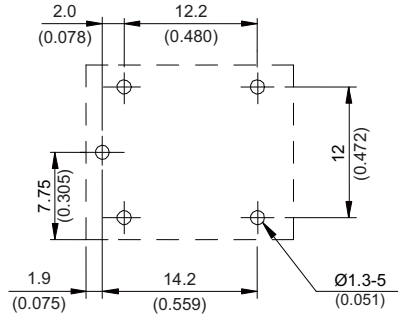

1A

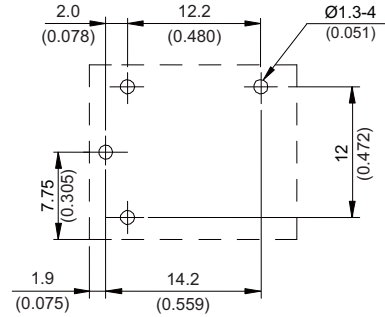

◆215A 1C

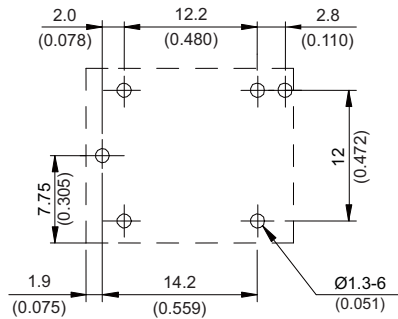

1A

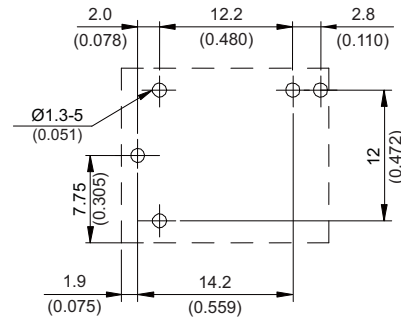

Engineering Data

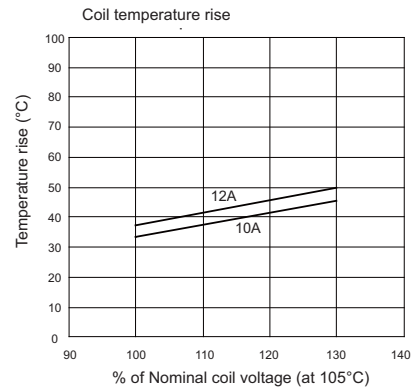
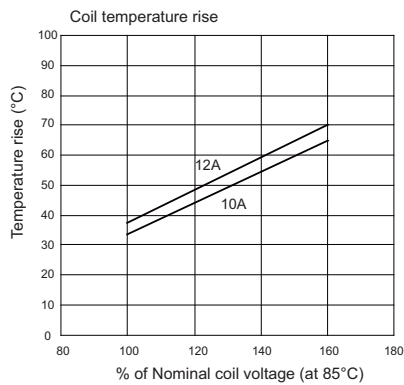
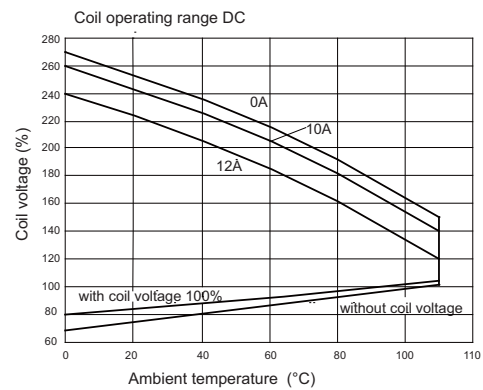
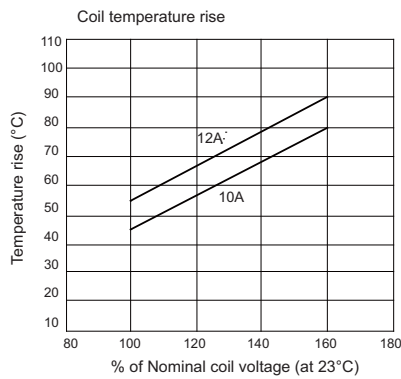

Mouser Electronics

Authorized Distributor

Click to View Pricing, Inventory, Delivery & Lifecycle Information:

[Song Chuan:](#)

[215H-1AH-F-C-12VDC](#) [215H-1CH-F-C-12VDC](#) [215H-1C-V-48VDC](#)